

Key-Link
Railing Systems

**American
RAILING**

AMERICAN ALUMINUM RAILING

KEY-LINK AMERICAN RAILING SERIES



KEYLINKONLINE.COM

AMERICAN ALUMINUM RAILING



The American Series features a flat top rail in a sleek and lightweight aluminum railing system that's finished in a weather resistant AAMA 2604 powder coating. Unique full-length PVC inserts in both rails creates a tighter and quieter fit.

-
- **1 $\frac{3}{4}$ " W x 1 $\frac{1}{8}$ " H Flat Top Rail**
 - **Self-Centering Mounting Brackets**
 - **10 Infill Options • 10+ Color Choices**
 - **Rattle-Free Vinyl Lined System**
 - **Easy to Install Boxed Railing Kits**
 - **Universal/Swivel Brackets Available**
 - **Limited Lifetime Warranty**
 - **Low Maintenance Aluminum**
 - **AAMA 2604 Rated Powder Coating**
 - **Performance Engineered & Tested To ICC Standards**
 - **Manufactured in USA**
 - **Heavy Wall Extruded Aluminum**
-

KEYLINKONLINE.COM

AMERICAN ALUMINUM RAILING

American Infill & Color Options

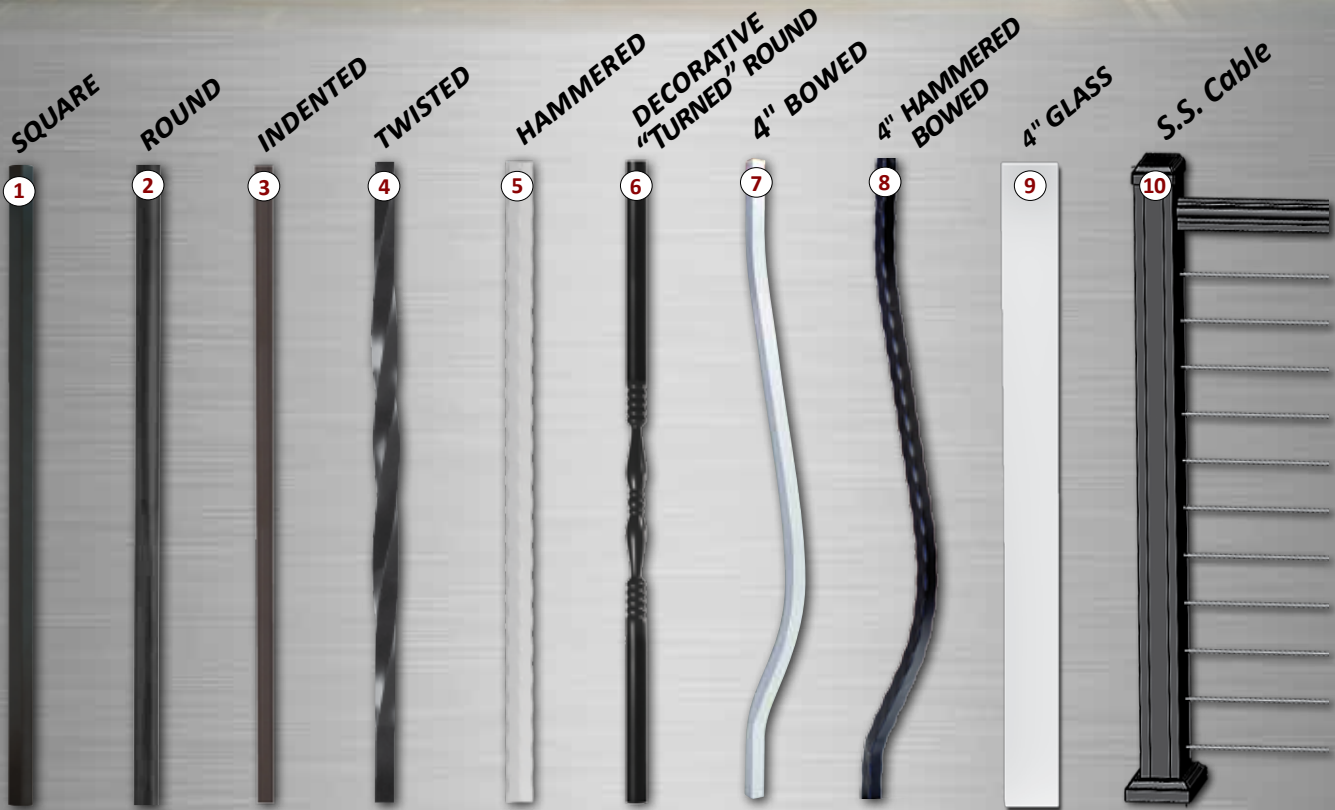

All Aluminum Balusters 3/4"

- Scranton (#1)
- Irvine (#3)
- Hartford (#5)
- Miami (#7)
- 4" Glass Baluster (#9)
- Raven (#2)
- Tioga (#4 & #1 Alt.)
- Dover (#6)
- Alpine (#8)
- Stainless Steel Cable Infill (#10)

STOCK COLORS FOR AMERICAN SERIES

- Textured Black
- Textured Bronze
- Textured White

SPECIAL ORDER COLORS FOR AMERICAN SERIES

- | | | | | |
|-------------|-------------|--------------|-----------------|---------|
| Gloss Black | Gloss White | Gloss Bronze | Hunter Green | Redwood |
| Gloss Beige | Kona | Brownstone | Speckled Walnut | Silver |

AMERICAN ALUMINUM RAILING



Square
Balusters



Round
Balusters

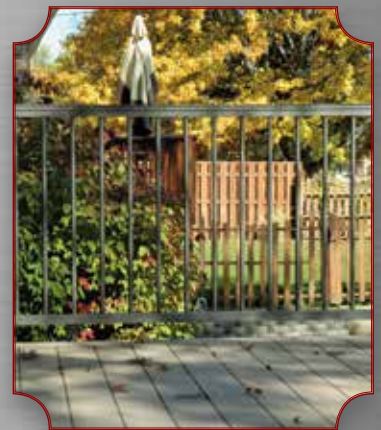

AMERICAN ALUMINUM RAILING

ALTERNATING
Square & Twisted
BALUSTERS



Hammered
Balusters

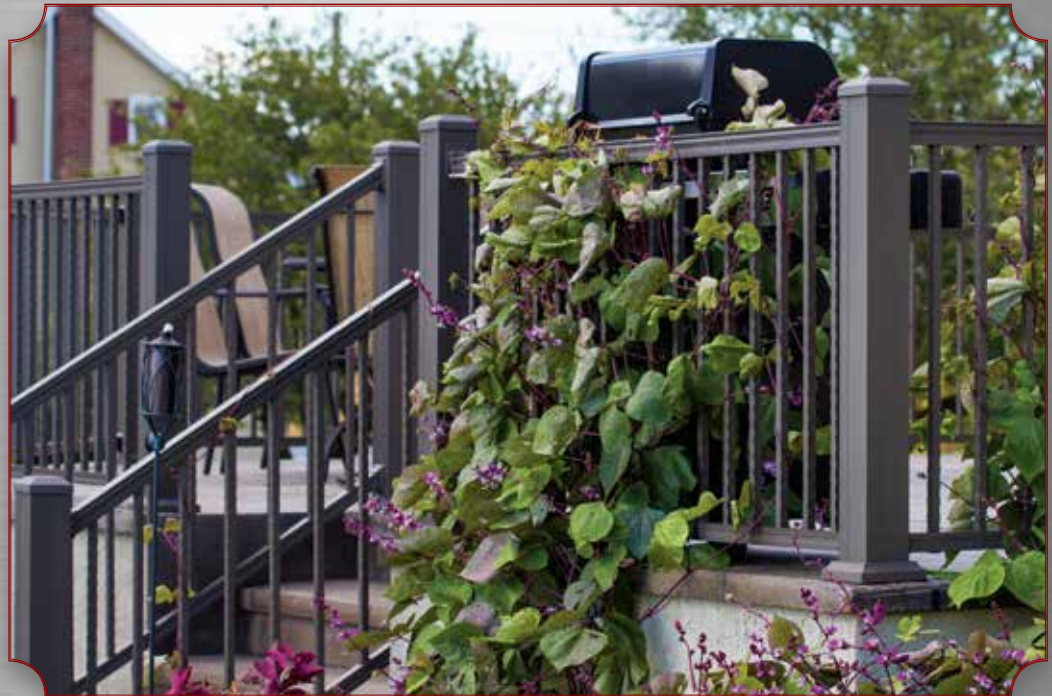

AMERICAN ALUMINUM RAILING



Decorative
Round
Balusters



Indented
Balusters



Glass Railing

Available in 6' sections.



Enjoy endless views with the Key-Link American Railing w/ Glass Balusters.



Railing balusters are no longer in your line of sight when sitting and relaxing on your porch or deck. The wonderful views you have worked so hard to create are now free of obstructions and visual distractions.

Curved Railing

Minimum radius 24°



Curved radiuses can be fabricated to your specifications.



AMERICAN ALUMINUM RAILING

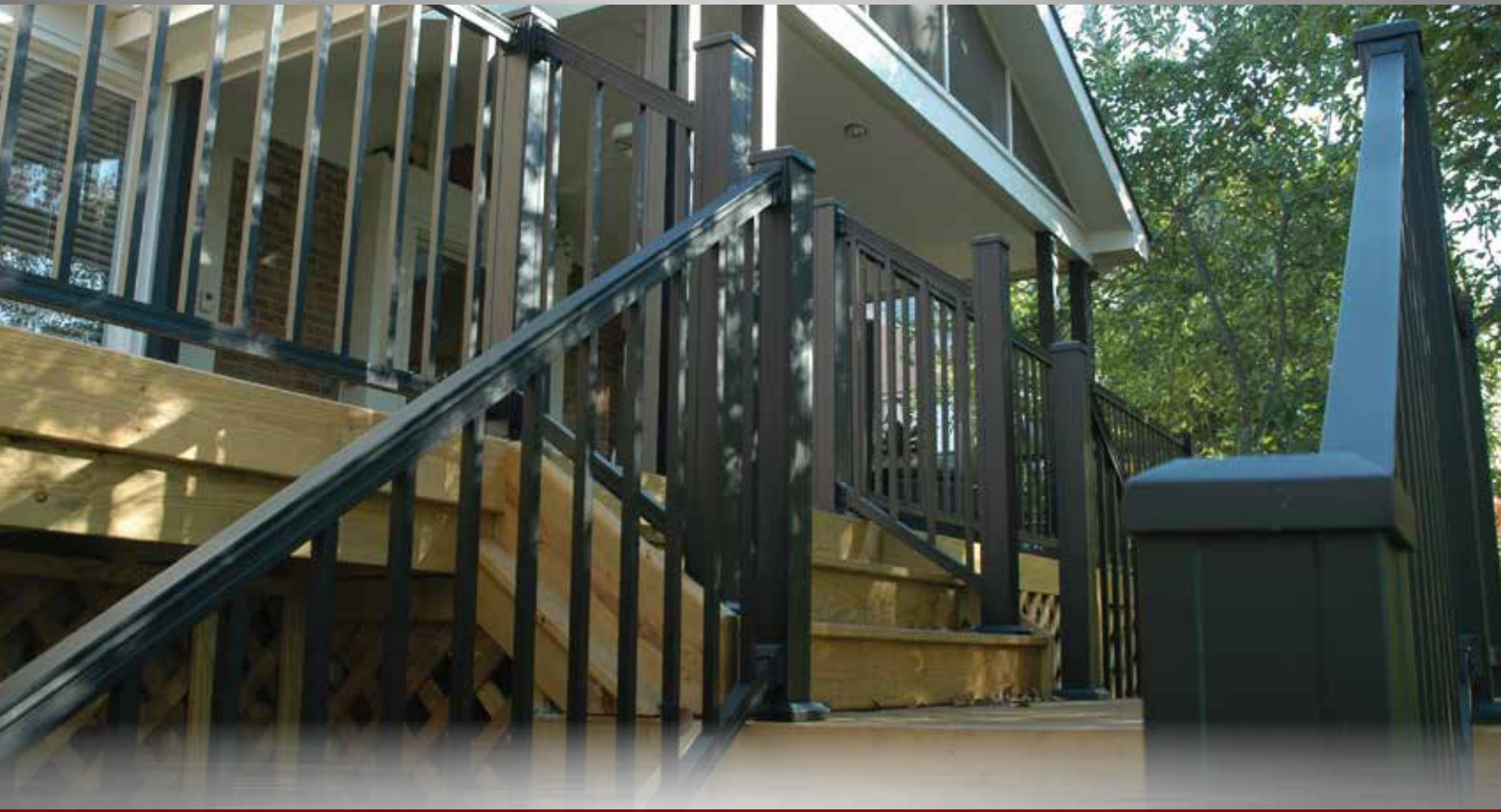

Indented Baluster



4" Hammered Bowed Picket



4" Bowed Picket



AMERICAN ALUMINUM RAILING

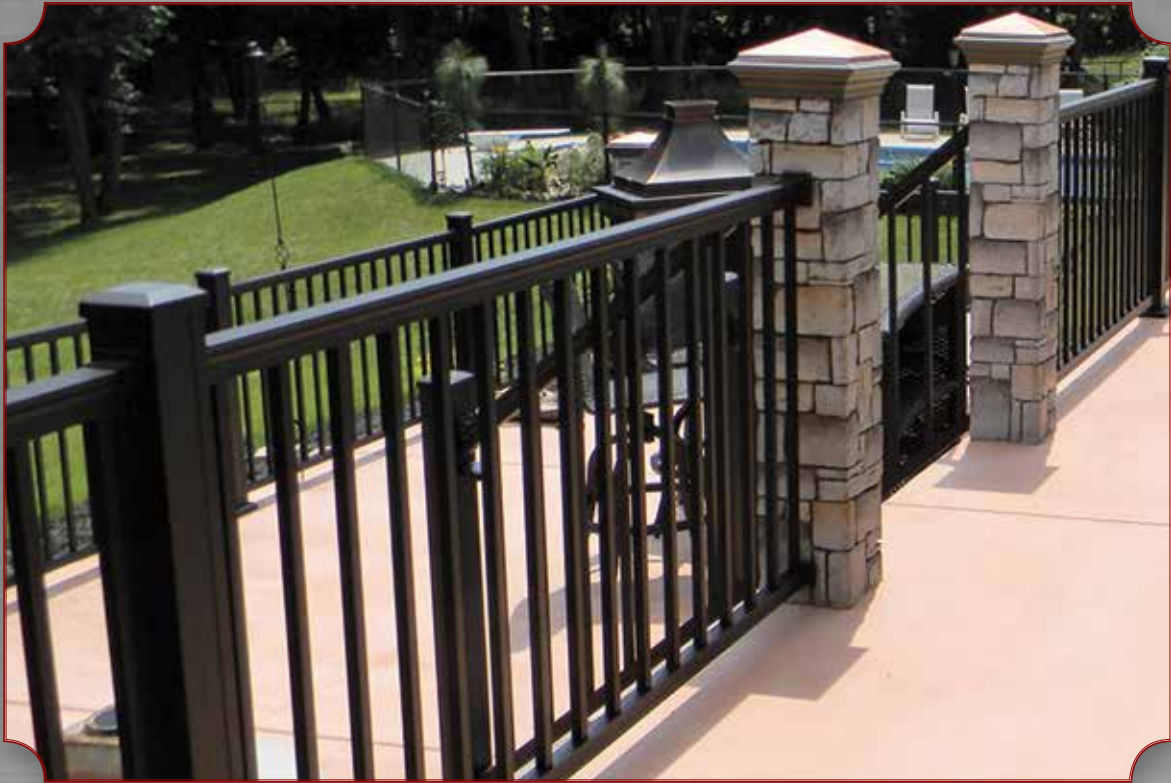

RAILING ACCESSORIES

AMERICAN RAIL PROFILE

Top Rail Specs



1 3/4" x 1 7/8"

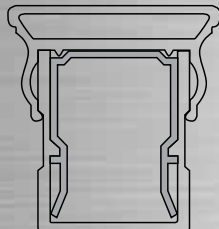

Bottom Rail Specs



1 1/4" x 1 1/2"

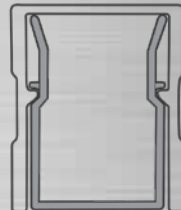

Drains in the bottom rail allow any moisture to escape

CROSS OVER ADAPTER

2 1/2" • 3 1/4" • 4"



Enables top rail to be installed on top of posts

BRACKETS/ADAPTERS

STRAIGHT TOP & BOTTOM BRACKETS

Set of 4 (2 each)



32° - 36° STAIR/STEP TOP & BOTTOM BRACKETS

Set of 4 (2 each)



UNIVERSAL SWIVEL MOUNTING BRACKETS

For use when up to 52 degrees is required in adjusting sections for stairs or slopes.

Set of 4 (2 each)

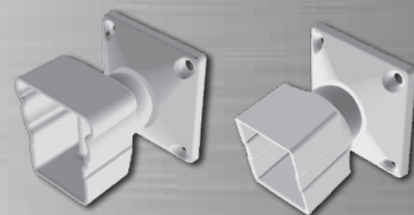

HORIZONTAL SWIVEL TOP & BOTTOM BRACKETS

Set of 4 (2 each)



Maximum 40° Swivel

VERTICAL STAIR SWIVEL TOP & BOTTOM BRACKETS

For use when an angle is required in adjusting sections for stairs or slopes.

Set of 4 (2 each)



Maximum 30° Swivel

45° TOP & BOTTOM BRACKET ADAPTERS

Set of 4 (2 each)



SIDE MOUNT POST BRACKET

For Side Mounting Railing

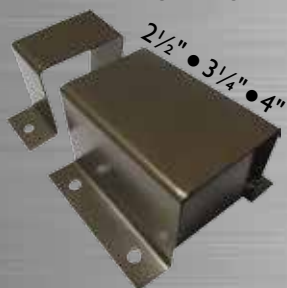

6" - 8" ROUND COLUMN BRACKET ADAPTER KIT

SET OF 4



UNIVERSAL STEP BRACKETS

Set of 4



RAILING ACCESSORIES



Ball Post Cap
(Optional)



Flat Post Cap
(Standard)



POST TRIM RING



CAPS/TRIM AVAILABLE IN 2½" • 3¼" • 4"

NEWEL POSTS
w/ 3/8" ALUM. PLATE

Can be installed on concrete, wood or composite decking for secure installations

AVAILABLE IN
2½" • 3¼" • 4"



LED POST CAPS
2½" or 4"



Black, Bronze or White

LAMBS TONGUE



END POST ACCENT



BALUSTER MOUNTS
Square mounts fit all balusters except round

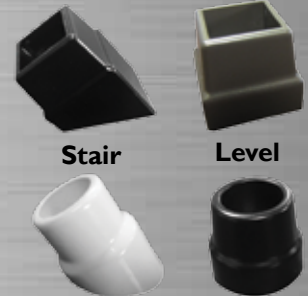

3 RAIL OPTIONS

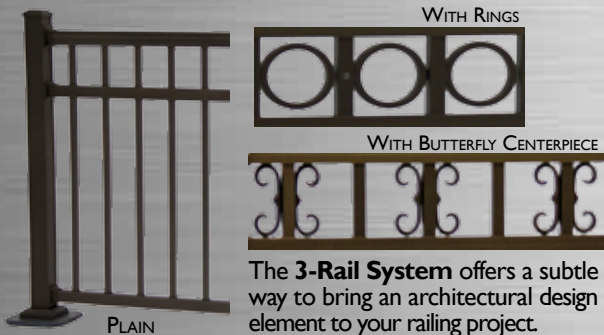

The **3-Rail System** offers a subtle way to bring an architectural design element to your railing project.

GINGERBREAD CORNER SCROLL

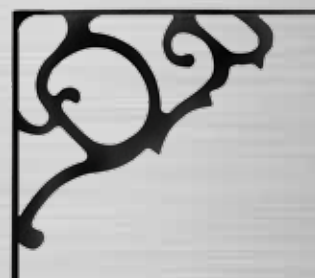

34 DEGREE ANGLE POST

Specifically designed to work with ramps. Comes standard with a welded plate.

AVAILABLE IN
2½" • 3¼" • 4"

SPECIAL ORDER
3-Week Lead Time



The balusters go through the routed rail to the top rail. Add rings or butterfly scrolls for a more dramatic look.

PORCH POSTS



3/4" x 3/4" x 108"

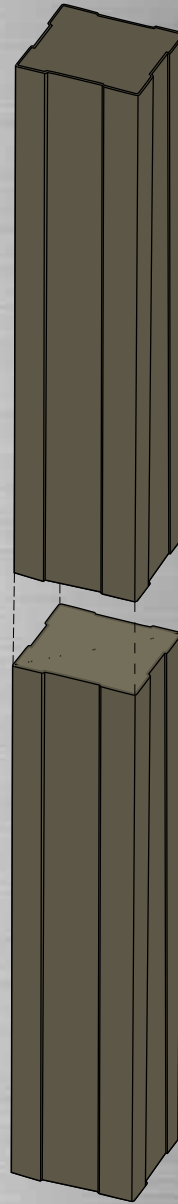

4" x 4" x 108"

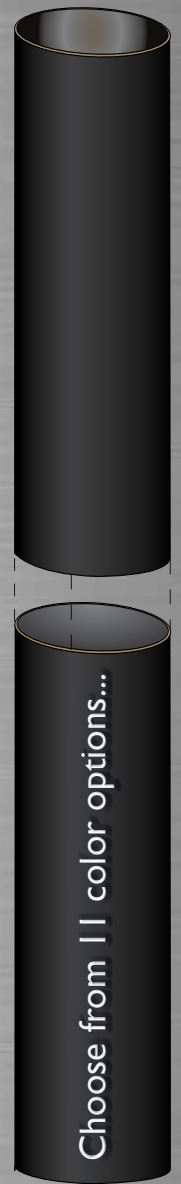

6" x 6" x 108"

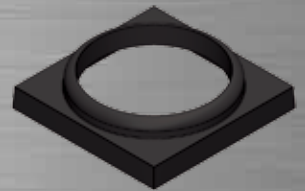

ALUMINUM ROUND COLUMN TRIM/MOUNTING BRACKET

7 1/2" x 7 1/2"

TRIM RING
All standard colors



3/4"



4"

MOUNTING BRACKETS
Included with porch posts



These hinges have been independently tested to comply with strict safety standards, especially those relating to stringent swimming pool safety codes. Always check with your township for your local building code requirements.

TruClose (Regular) Multi-Adjustable Hinge



- Horizontal adjustment up to 1-1/8" & Vertical adjustment up to 3/4"
- Self closing gate rating of 55 lbs. • Dim. 3-3/4" high by 4" wide
- Gate gap variance from 7/8" to 1-1/2" • Ideal gate gap of 1-1/8"
- Molded polymer construction with adjustable stainless steel torsion spring
- Side legs wrap around fence post & edge of gate for added strength

Max Load Cap.
375 lbs.

(Black) Model #TCAMA1 (White) Model #TCAMA2WT

TruClose (Heavy Duty) Multi-Adjustable Hinge



- Horizontal & Vertical adjustments up to 3/4"
- Self closing gate rating of 132 lbs. • Dim. 5" high by 7" wide
- Gate gap variance from 5/8" to 1-3/8" • Ideal gate gap of 1"
- Molded polymer construction with adjustable stainless steel torsion spring
- Side legs wrap around fence post & edge of gate for added strength

Max Load Cap.
700 lbs.

(Black) Model #TCHDMA1 (White) Model #TCHDMA1WT

TruClose (Regular) Hinge for Round Posts



- Includes shims/adapters to fit different post and gate diameters
- Self closing gate rating of 55 lbs. • Dim. 4" high by 4" wide
- Gate gap variance from 7/8" to 1-1/2" • Ideal gate gap of 1-1/8"
- Molded polymer construction with adjustable stainless steel torsion spring
- Side legs wrap around fence post & edge of gate for added strength

Max Load Cap.
375 lbs.

(Black) Model #TCAMA2RND

TruClose (Heavy Duty) Hinge for Round Posts



- Includes shims/adapters to fit different post and gate diameters
- Self closing gate rating of 132 lbs. • Dim. 5" high by 4-1/8" wide
- Gate gap variance from 3/4" to 1-3/8" • Ideal gate gap of 1"
- Molded polymer construction with adjustable stainless steel torsion spring
- Side legs wrap around fence post & edge of gate for added strength

Max Load Cap.
700 lbs.

(Black) Model #TCHDRND1-MK2

TruClose Self-Closing Gate Hinge



- Horizontal adjustment up to 1-1/8" & Vertical adjustment up to 3/4"
- Self closing gate rating of 66 lbs. • Dim. 5" high by 4" wide
- Gate gap variance from 7/8" to 1-1/2" • Ideal gate gap of 3/4"
- Molded polymer construction with adjustable stainless steel torsion spring
- Side legs wrap around fence post & edge of gate for added strength

Max Load Cap.
770 lbs.

(Black) Model #TCAIL2S3BT (White) Model #TCAIL2S3WT

Heavy Duty Self-Closing S.S. Adjustable Hinge



- Sold by the pair • Designed for larger, heavier vinyl gates
- Large enclosed spring provides increased closing power
- Very easy tension adjustment • Horizontally Adjustable
- Used with 2" or Larger Gate Profiles
- Post Flange: 4.5" (H) x 3.25" (W) x 1.25" (D)
- Gate Flange: 3.5" (H) x 2.75" (W) x 1.25" (D)
- 304 Series Stainless Steel/ Powder Coated

(Black) Model #NWSS-HD-SC-BK

MAGNALatch ALERT Child Safety Latch



- NEW Visual unlatched alarm
- NEW Audible unlatched alarm
- At-a-glance Lock Indicator
- Fits to metal and wood gates
- Trusted for over 25 years
- Meets all pool barrier codes
- Re-keyable lock for security & convenience
- Magnetic latching always engages, can't jam
- Easy installation, with no special tools

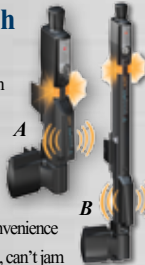

A - (Black) Model #ML3AVPKA Vertical Pull Safety Latch Alert for Gates 60" or Higher Key Lockable • Gate Gap 1/2" - 1-1/2" 12-7/16" High

B - (Black) Model #ML3ATPKA Top Pull Safety Latch Alert for Gates 48" or Higher Key Lockable • Gate Gap 1/2" - 1-1/2" 20-1/2" High

For larger gaps of 1-1/2" - 2" ask about optional spacer that's available

MAGNALatch (Non-Alert) Child Safety Latch



(Black) 10" Vertical Pull Model #ML3VPKA

(Black) 20" Top Pull Model #ML3TPKA

Accommodates Gate Gaps of 1/2" - 1-1/2"

Magna Latch (Pool code approved)

Lockable Gate Latch



- Strong & 100% rust proof
- No need for padlocks
- Fits all gate materials
- Quick & easy installation
- Gap variance 3/8" to 1-3/8"
- Up to 6" post size

(Black) Model #LLAA
(White) Model #LLAAW

Lockable Gate Latch (Deluxe)



- Strong & 100% rust proof
- Operates/locks both sides
- Re-keyable 6-pin locks
- Quick & easy installation
- Gap variance 5/8" to 1-1/2"
- Up to 6" post size

(Black) Model #LLDAB-K
(White) Model #LLDABW-K

Lockable Gate Latch (Magnetic)



- Strong & 100% rust proof
- Operates/locks both sides
- Re-keyable 6-pin locks
- Quick & easy installation
- Gap variance 3/8" to 1-1/4"
- Post size 1-1/2" to 6"

(Black) Model #LLMKABT

Manta Magnetic Latch



- Strong nylon material
- Self-latching, key lockable
- Re-keyable to home locks
- Reversible for L/R
- Adj. Gap 1/2" to 2"

• Positive-locking magnetic system • Includes 4 keys
(Black) Model #MANTA-L-BK
(White) Model #MANTA-L-WH

LokkLatch External Access Kit



Optional Kit External Access Kit Lockable Push-Button operates latch from outside the fence.

(Black) Model #LLB
(White) Model #LLBW

LokkBolt Lockable Security Drop Bolt

The LokkBolt is a lockable security bolt that provides long-lasting privacy and security in a superbly stylish drop bolt for all types of gates, especially double-drive gates. LokkBolt is key-lockable

(18" Black) Model #LB118BX-KSA
(18" White) Model #LB118BXW-KSA
(24" Black) Model #LB124BX-KSA
(24" White) Model #LB124BXW-KSA



Heavy Duty Drop Pin Plate



This Base Plate offers added strength for your LokkBolt installation. It reinforces the securing ground hole. Molded, rust-free plate to add a stylish finish.

(Black) Model #LBBPBG

Gate Handle



- Convenient gate opening & closing
- Fits all gates, left/right openings
- Simple & stylish
- Strong & 100% rust proof

(Black) Model #LL3GH
(White) Model #LLHBGWT

20" AquaLatch w/Handle



- Highly child resistant
 - 45° Key lockable for EZ access
 - Two keys provided
 - Easy Adjustments
 - Left/right hand applications
 - Built-in handle available
 - Automatic magnetic latching
 - Easy grip release knob
 - Safe-Alert™ provides a visual alert when the latch is not engaged
 - Available in black or white
- (Black) Model #AQUA-20-BK
(White) Model #AQUA-20-WH



Secondary Handrail

1 1/2" STANDARD MOUNTING BRACKET



1 1/2" ROUND HANDRAIL 104" LENGTH



1 1/2" 90° RETURN BRACKET



1 1/2" END WALL MOUNT



34° RADIUS ELBOW



5° RADIUS ELBOW



1 1/2" OUTSIDE ELBOW



90° RADIUS ELBOW



1 1/2" CONNECTOR



6" CORNER MOUNTING BRACKET

1 1/2" END CAP



"P" LOOP RETURN

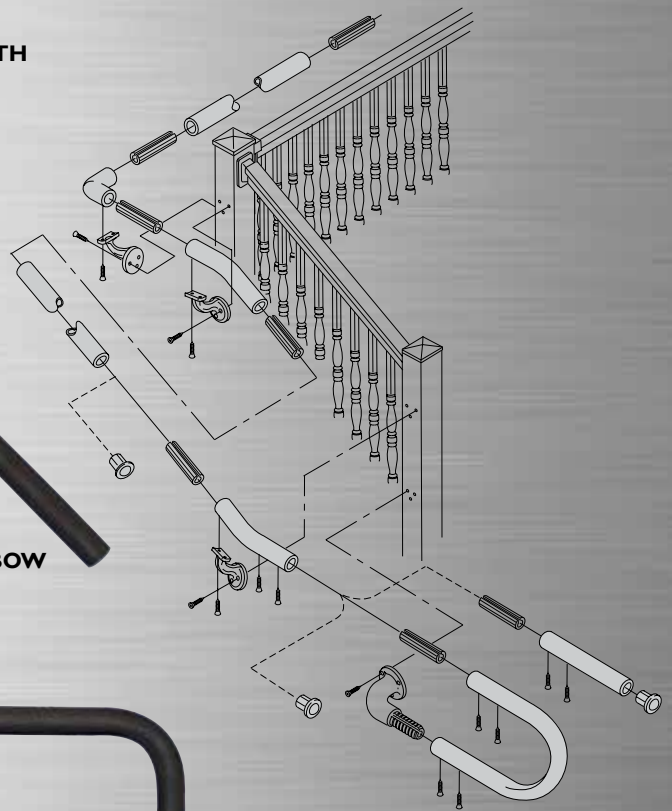

SECONDARY HANDRAIL

STOCK COLORS

Textured Black

Textured White

Textured Bronze

Gloss Black

Gloss White

Gloss Bronze

Silver

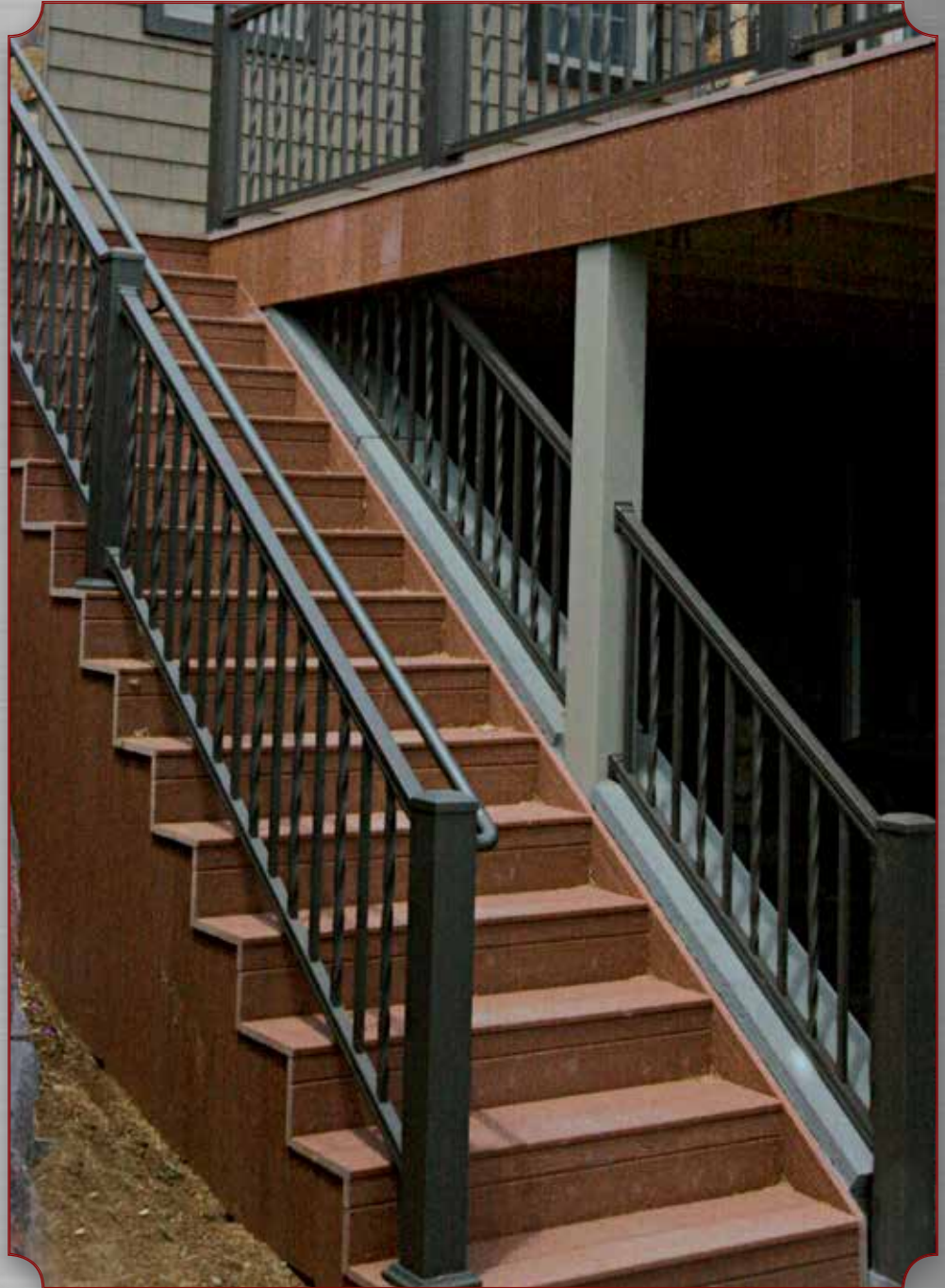

Secondary Railing Special Order Colors

Speckled Walnut

Brownstone

Gloss Beige

Hunter Green

Redwood

Kona

PHOTO GALLERY



150 Orlan Road | New Holland, PA 17557



DEALER

Item# DIAMRCAT

